

TCI

MOTORGUARD™

High Performance Output Filters
Performance and Protection for Drives



TCI's MOTORGUARD™

High Performance Output Filters are the Next Generation in Motor Protection

In the continuing search to improve energy efficiency, many commercial and industrial power systems are turning to the technology of PWM (pulse width modulated) output power supplies. The ability to convert standard utility power into variable-frequency, variable-voltage electrical power has led to more efficient and economical installations. One of the drawbacks of the use of equipment such as adjustable frequency drives and variable frequency/voltage power supplies is that the output of such PWM devices is a square wave form. Many applications require a more sinusoidal output, thus ruling out these economical and efficient solutions.

The MotorGuard High Performance Output Filter has been designed to be installed at the output terminals of PWM devices. The KMG filter converts the PWM wave form to a near sinusoidal wave form, allowing sensitive applications to take advantage of the efficiencies and savings that PWM output power supplies offer.

Manufacturer's Warranty

KMG Output Filters are warranted against Manufacturer's defect for one year of useful service, not to exceed 18 months from the date of shipment.

Performance Guarantee

Properly applied and sized for the application, the addition of a KMG Output Filter is guaranteed to bring the application into compliance with NEMA Standards Publication No. MG-1. If the system fails to meet MG-1 standards with the addition of a KMG filter, TCI will take back the output filter and pay shipping both ways. (Offer valid for 60 days from purchase date.)

Drawings/Specifications

Autocad compatible *.dxf drawings and Acrobat Reader compatible *.pdf drawings of all MotorGuard Sine Wave Filters are available at www.transcoil.com or by contacting TCI at (800) 824-8282. The Installation, Operation, and Maintenance Manual is also available for download.

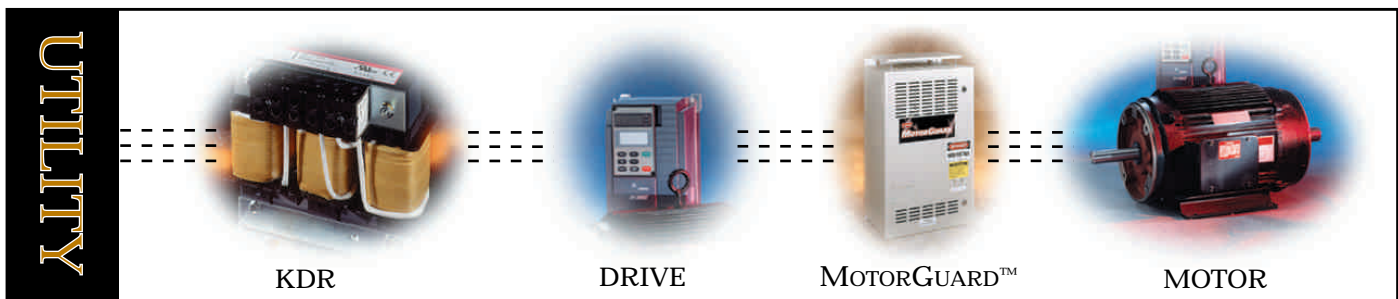

Typical Problems, Superior Solutions with KMG Filters

PWM (Pulse Width Modulated) Output Power Supplies

Voltage wave reflection, a function of voltage rise time (dV/dt), occurs due to the impedance mismatch between the output of the PWM power supply and the load. This mismatch causes some portion of the high frequency leading edge to be reflected back in the direction from which it arrived. These reflected waves meet other incoming wave forms, causing higher and higher voltage overshoots. This high voltage can cause early degradation of insulation systems, not only for motors, but also transformers and cables.

The KMG filter is designed to attenuate the carrier components present in the output waveform of typical PWM output power supplies. The general filter topology is an L-C-R low pass circuit. The circuit input is a three phase reactor of sufficient impedance to control the capacitor charging below the inverter peak current fault point. The filter cutoff frequency is set approximately ten times the max allowed fundamental frequency of the inverter to minimize the fundamental KVAR absorbed by the filter while attenuating the carrier components at the rate of 40db per decade. This allows carriers greater than 2KHz to effectively be eliminated from the output of the filter. The purpose of the damping resistor is to control the over voltage excursion at the cutoff frequency to a reasonable level and keep the peak capacitor currents within design limits. An added benefit of the low pass configuration is the capacitive reactance at the load will provide motor power factor improvement thereby improving the overall filter insertion loss to that of the resistor and inductor thermal levels, typically about 2-3% of the inverter full load level.

PWM Output Power Supply Terminals - Unfiltered

Voltage

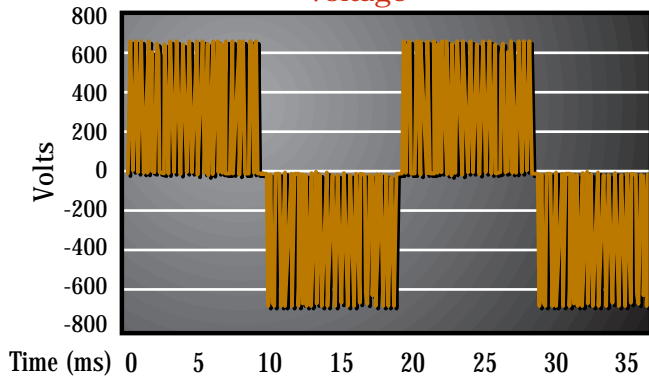

Current

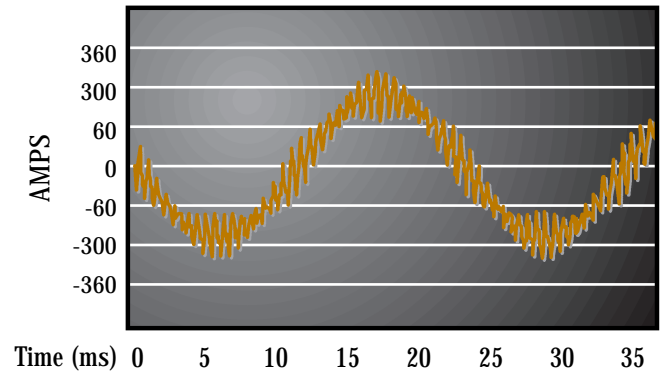

Motor Terminals - Unfiltered

Voltage

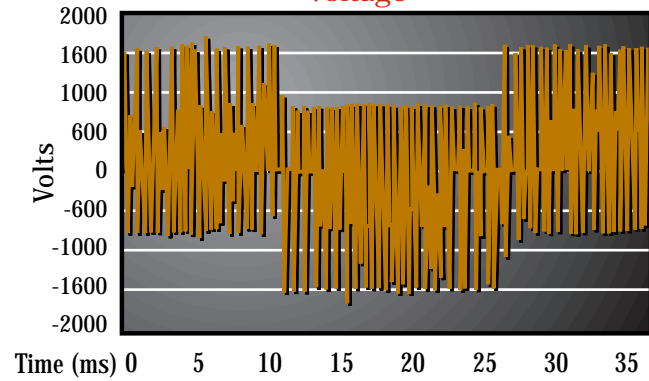

Current

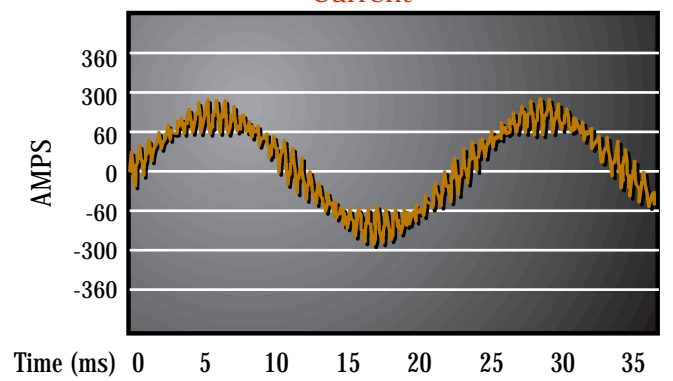

Motor Terminals - MOTORGUARD™

Voltage

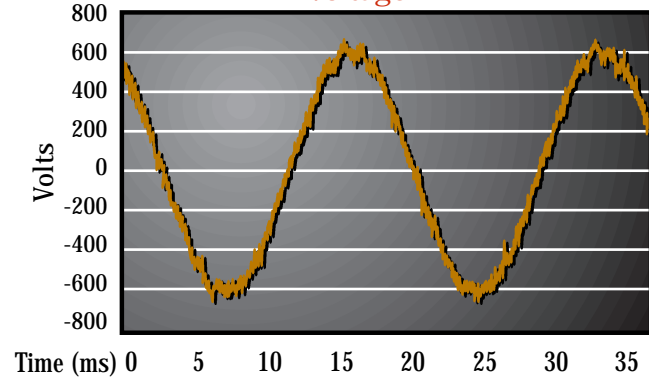

Current

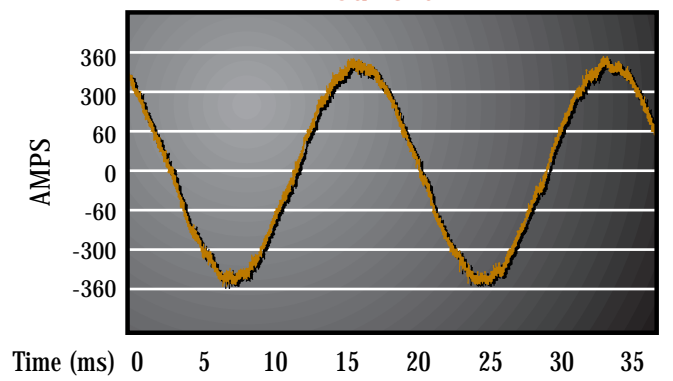

Motor Terminals - MOTORGUARD™

No Load Voltage

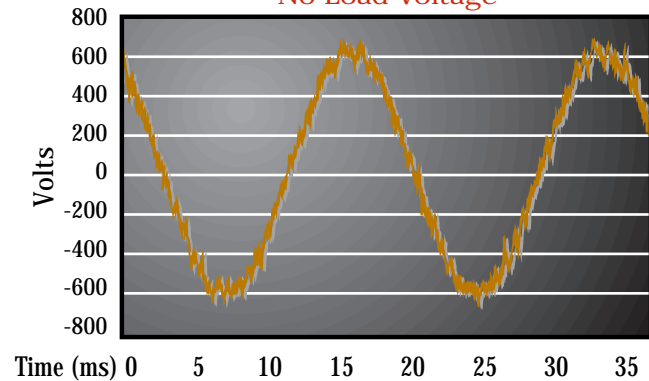

Full Load Voltage

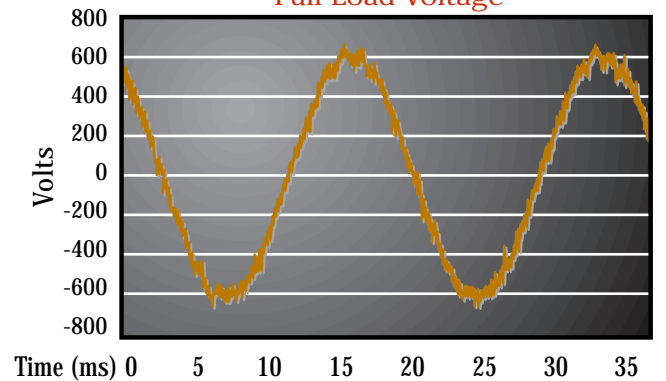

480 Volt Selection Charts

480 Volt OPEN	NOMINAL H.P.	PART NUMBER	MAX CURRENT	WATTS LOSS	WIRE RANGE	GROUND LUG WIRE RANGE	DIMENSIONS			
							H	W	D	LBS
5	KMG8A	8	300	2 AWG to 22 AWG *	1/0-14	30.75	17.00	12.00	60	
7.5	KMG12A	12	350	2 AWG to 22 AWG *	1/0-14	30.75	17.00	12.00	60	
10	KMG16A	16	400	2 AWG to 22 AWG *	1/0-14	30.75	17.00	12.00	70	
15	KMG23A	23	550	2 AWG to 22 AWG *	1/0-14	30.75	17.00	12.00	75	
20	KMG30A	30	650	2 AWG to 22 AWG *	1/0-14	30.75	17.00	12.00	85	
25	KMG35A	35	750	2 AWG to 22 AWG *	1/0-14	30.75	17.00	12.00	85	
30	KMG45A	45	850	2 AWG to 22 AWG *	1/0-14	30.75	17.00	12.00	100	
40	KMG55A	55	1000	2 AWG to 22 AWG *	1/0-14	30.75	17.00	12.00	115	
50	KMG65A	65	1100	2/0-6	2/0-6	56.00	17.00	14.00	160	
60	KMG80A	80	1550	2/0-6	2/0-6	56.00	17.00	14.00	175	
75	KMG110A	110	1700	2/0-6	2/0-6	56.00	17.00	14.00	195	
100	KMG130A	130	2050	2/0-6	2/0-6	56.00	17.00	14.00	200	
125	KMG160A	160	2450	250MCM-6	250MCM-6	56.00	17.00	14.00	250	
150	KMG200A	200	3300	250MCM-6	250MCM-6	56.00	17.00	14.00	255	
200	KMG250A	250	3700	600 MCM-4 **	600 MCM-4 **	60.00	32.00	20.00	445	
250	KMG305A	305	4700	600 MCM-4 **	600 MCM-4 **	60.00	32.00	20.00	460	
300	KMG362A	362	4650	(2)350MCM-4	(2)350MCM-4	60.00	32.00	20.00	475	
350	KMG420A	420	5400	(2)600MCM-2	(2)600MCM-2	60.00	32.00	20.00	580	
400	KMG480A	480	6050	(2)600MCM-2	(2)600MCM-2	60.00	32.00	20.00	635	
500	KMG600A	600	7350	(2)600MCM-2	(2)600MCM-2	60.00	32.00	20.00	645	
600	KMG750A	750	8800	(3)600MCM-2	(3)600MCM-2	60.00	32.00	20.00	760	

* Connections can also handle 1 AWG (7 & 19 STRAND ONLY)

** Connections can also handle (2)250MCM-1/0

480 Volt ENCLOSED	NOMINAL H.P.	PART NUMBER	MAX CURRENT	WATTS LOSS	WIRE RANGE	GROUND LUG WIRE RANGE	DIMENSIONS			
							H	W	D	LBS
5	KMG8AE01	8	300	2 AWG to 22 AWG *	1/0-14	31.38	17.50	12.12	110	
7.5	KMG12AE01	12	350	2 AWG to 22 AWG *	1/0-14	31.38	17.50	12.12	110	
10	KMG16AE01	16	400	2 AWG to 22 AWG *	1/0-14	31.38	17.50	12.12	120	
15	KMG23AE01	23	550	2 AWG to 22 AWG *	1/0-14	31.38	17.50	12.12	125	
20	KMG30AE01	30	650	2 AWG to 22 AWG *	1/0-14	31.38	17.50	12.12	140	
25	KMG35AE01	35	750	2 AWG to 22 AWG *	1/0-14	31.38	17.50	12.12	140	
30	KMG45AE01	45	850	2 AWG to 22 AWG *	1/0-14	31.38	17.50	12.12	155	
40	KMG55AE01	55	1000	2 AWG to 22 AWG *	1/0-14	31.38	17.50	12.12	170	
50	KMG65AE01	65	1100	2/0-6	2/0-6	56.00	17.50	16.40	245	
60	KMG80AE01	80	1550	2/0-6	2/0-6	56.00	17.50	16.40	260	
75	KMG110AE01	110	1700	2/0-6	2/0-6	56.00	17.50	16.40	280	
100	KMG130AE01	130	2050	2/0-6	2/0-6	56.00	17.50	16.40	300	
125	KMG160AE01	160	2450	250MCM-6	250MCM-6	56.00	17.50	16.40	340	
150	KMG200AE01	200	3300	250MCM-6	250MCM-6	56.00	17.50	16.40	345	
200	KMG250AE01	250	3700	600 MCM-4 **	600 MCM-4 **	78.00	36.00	24.00	770	
250	KMG305AE01	305	4700	600 MCM-4 **	600 MCM-4 **	78.00	36.00	24.00	790	
300	KMG362AE01	362	4650	(2)350MCM-4	(2)350MCM-4	78.00	36.00	24.00	800	
350	KMG420AE01	420	5400	(2)600MCM-2	(2)600MCM-2	78.00	36.00	24.00	915	
400	KMG480AE01	480	6050	(2)600MCM-2	(2)600MCM-2	78.00	36.00	24.00	970	
500	KMG600AE01	600	7350	(2)600MCM-2	(2)600MCM-2	78.00	36.00	24.00	975	
600	KMG750AE01	750	8800	(3)600MCM-2	(3)600MCM-2	78.00	36.00	24.00	1085	

* Connections can also handle 1 AWG (7 & 19 STRAND ONLY)

** Connections can also handle (2)250MCM-1/0

Typical Applications

- Extreme long motor lead lengths. Specific applications can reach 15,000 feet.
- Low voltage PWM power supply to medium voltage motor.
- Multiple motor applications such as conveyors, blowers, pumps, and fans.
- Test floor and test stand applications.
- Shore to ship power for non-60 Hz systems.
- HVAC systems to reduce audible noise within air distribution ducts and fans.

600 Volt Selection Charts

600 Volt OPEN	NOMINAL H.P.	PART NUMBER	MAX CURRENT	WATTS LOSS	WIRE RANGE	GROUND LUG WIRE RANGE	DIMENSIONS			
							H	W	D	LBS
	5	KMG8C	8	400	2 AWG to 22 AWG *	1/0-14	30.75	17.00	12.00	60
	7.5	KMG10C	10	400	2 AWG to 22 AWG *	1/0-14	30.75	17.00	12.00	65
	10	KMG12C	12	400	2 AWG to 22 AWG *	1/0-14	30.75	17.00	12.00	70
	15	KMG20C	20	550	2 AWG to 22 AWG *	1/0-14	30.75	17.00	12.00	75
	20	KMG25C	25	700	2 AWG to 22 AWG *	1/0-14	30.75	17.00	12.00	85
	25	KMG28C	28	750	2 AWG to 22 AWG *	1/0-14	30.75	17.00	12.00	90
	30	KMG35C	35	800	2 AWG to 22 AWG *	1/0-14	30.75	17.00	12.00	100
	40	KMG45C	45	950	2 AWG to 22 AWG *	1/0-14	30.75	17.00	12.00	115
	50	KMG55C	55	1200	2 AWG to 22 AWG *	1/0-14	56.00	17.00	14.00	160
	60	KMG65C	65	1600	2/0-6	2/0-6	56.00	17.00	14.00	175
	75	KMG80C	80	1650	2/0-6	2/0-6	56.00	17.00	14.00	195
	100	KMG110C	110	2250	2/0-6	2/0-6	56.00	17.00	14.00	225
	125	KMG130C	130	2300	2/0-6	2/0-6	56.00	17.00	14.00	250
	150	KMG160C	160	2500	250MCM-6	250MCM-6	56.00	17.00	14.00	260
	200	KMG200C	200	3500	250MCM-6	250MCM-6	60.00	32.00	20.00	450
	250	KMG250C	250	4500	600 MCM-4 **	600 MCM-4 **	60.00	32.00	20.00	460
	300	KMG305C	305	5100	600 MCM-4 **	600 MCM-4 **	60.00	32.00	20.00	475
	350	KMG362C	362	6100	(2)350MCM-4	(2)350MCM-4	60.00	32.00	20.00	580
	400	KMG420C	420	6900	(2)350MCM-4	(2)350MCM-4	60.00	32.00	20.00	635
	500	KMG500C	500	7900	(2)600MCM-2	(2)600MCM-2	60.00	32.00	20.00	645
	600	KMG600C	600	9000	(2)600MCM-2	(2)600MCM-2	60.00	32.00	20.00	750

* Connections can also handle 1 AWG (7 & 19 STRAND ONLY)

** Connections can also handle (2)250MCM-1/0

600 Volt ENCLOSED	NOMINAL H.P.	PART NUMBER	MAX CURRENT	WATTS LOSS	WIRE RANGE	GROUND LUG WIRE RANGE	DIMENSIONS			
							H	W	D	LBS
	5	KMG8CE01	8	400	2 AWG to 22 AWG *	1/0-14	31.38	17.50	12.12	115
	7.5	KMG10CE01	10	400	2 AWG to 22 AWG *	1/0-14	31.38	17.50	12.12	115
	10	KMG12CE01	12	400	2 AWG to 22 AWG *	1/0-14	31.38	17.50	12.12	120
	15	KMG20CE01	20	550	2 AWG to 22 AWG *	1/0-14	31.38	17.50	12.12	135
	20	KMG25CE01	25	700	2 AWG to 22 AWG *	1/0-14	31.38	17.50	12.12	140
	25	KMG28CE01	28	750	2 AWG to 22 AWG *	1/0-14	31.38	17.50	12.12	145
	30	KMG35CE01	35	800	2 AWG to 22 AWG *	1/0-14	31.38	17.50	12.12	155
	40	KMG45CE01	45	950	2 AWG to 22 AWG *	1/0-14	31.38	17.50	12.12	175
	50	KMG55CE01	55	1200	2 AWG to 22 AWG *	1/0-14	56.00	17.50	16.40	260
	60	KMG65CE01	65	1600	2/0-6	2/0-6	56.00	17.50	16.40	265
	75	KMG80CE01	80	1650	2/0-6	2/0-6	56.00	17.50	16.40	265
	100	KMG110CE01	110	2250	2/0-6	2/0-6	56.00	17.50	16.40	290
	125	KMG130CE01	130	2300	2/0-6	2/0-6	56.00	17.50	16.40	295
	150	KMG160CE01	160	2500	250MCM-6	250MCM-6	56.00	17.50	16.40	340
	200	KMG200CE01	200	3500	250MCM-6	250MCM-6	78.00	36.00	24.00	770
	250	KMG250CE01	250	4500	600 MCM-4 **	600 MCM-4 **	78.00	36.00	24.00	775
	300	KMG305CE01	305	5100	600 MCM-4 **	600 MCM-4 **	78.00	36.00	24.00	790
	350	KMG362CE01	362	6100	(2)350MCM-4	(2)350MCM-4	78.00	36.00	24.00	975
	400	KMG420CE01	420	6900	(2)350MCM-4	(2)350MCM-4	78.00	36.00	24.00	975
	500	KMG500CE01	500	7900	(2)600MCM-2	(2)600MCM-2	78.00	36.00	24.00	1015
	600	KMG600CE01	600	9000	(2)600MCM-2	(2)600MCM-2	78.00	36.00	24.00	1015

* Connections can also handle 1 AWG (7 & 19 STRAND ONLY)

** Connections can also handle (2)250MCM-1/0

Application Benefits

- Reduced common mode current
 - Reduction in bearing currents
 - Reduction in instrumentation reference to ground noise
- Reduced motor noise, vibration, and heat
 - Increase in motor life
- Elimination of torque ripple
- Elimination of voltage wave reflection
- Enables systems to meet NEMA MG-1, Part 31 specification

Considerations when Applying KMG Filters

KMG High Performance Output Filters have been designed for a wide range of applications. Below, please find general guidelines in reference to the selection and application of the KMG Filter. For more specific installation information, please refer to the MotorGuard Installation, Operation, and Maintenance Manual.

Basic Installation Guidelines

- Selection of filter is based on the full load amps of the motor or motors.
- Provide sufficient ventilation. Unit loss characteristics can be found on the selection chart on the previous pages.
- Mount the unit within ten (wire) feet from the variable frequency or adjustable speed drive.
- Insure the drive's carrier frequency is set between 2 kHz and 4 kHz, and the operating frequency is set to 80 Hz or below.
- The mode of operation must be "scalar" or "V/Hz" without DC braking unless the drive application has been confirmed by TCI Technical Support.
- 120 VAC single-phase power is required for the monitor board and cooling fan. The power source cannot be supplied from the output of the drive.
- Connect the drive output leads to the U, V, and W terminations of the KMG Filter. T1, T2, and T3 service the wire to the motor.
- If system requirements are outside of the above recommendations, please consult TCI Technical Support.

Extreme Long Lead Applications



Low Voltage PWM Power Supply to Medium Voltage Motor

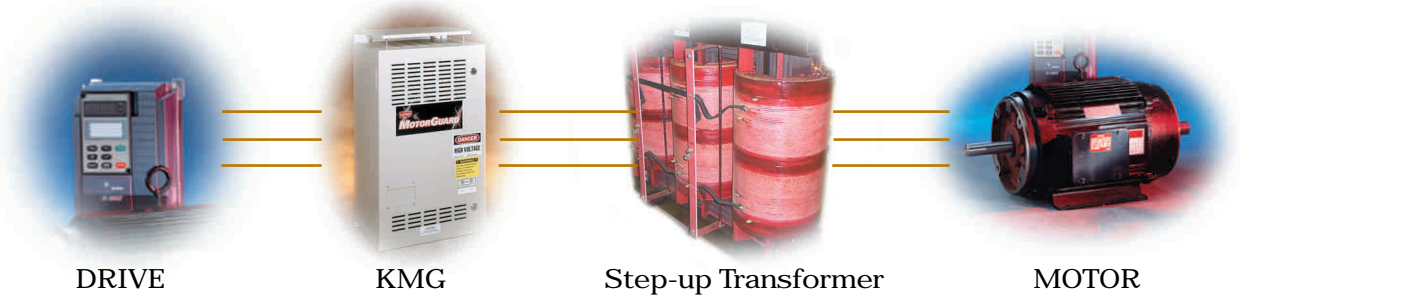

Multiple Motor Applications

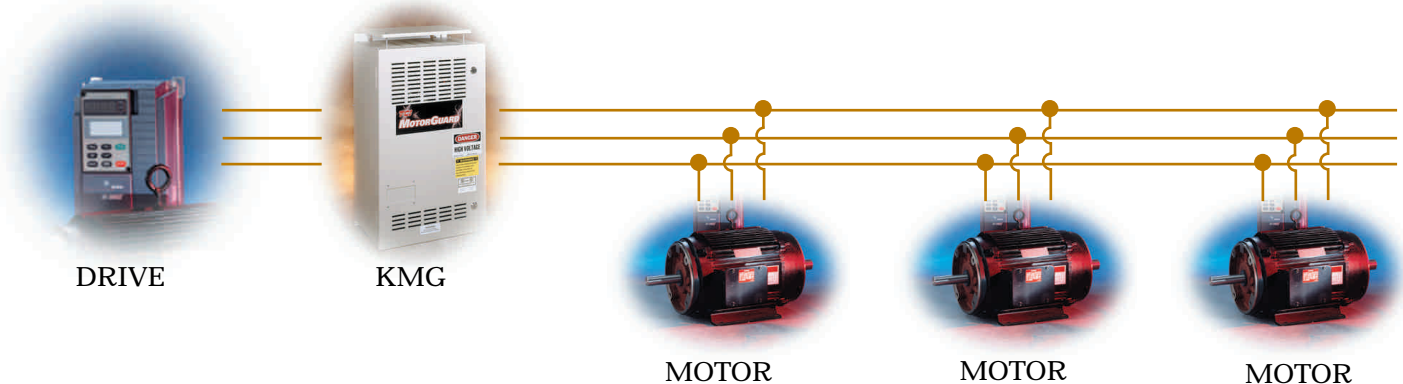

MOUNTING DIAGRAMS

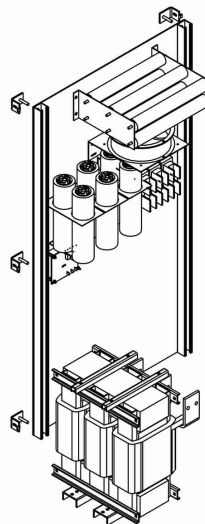
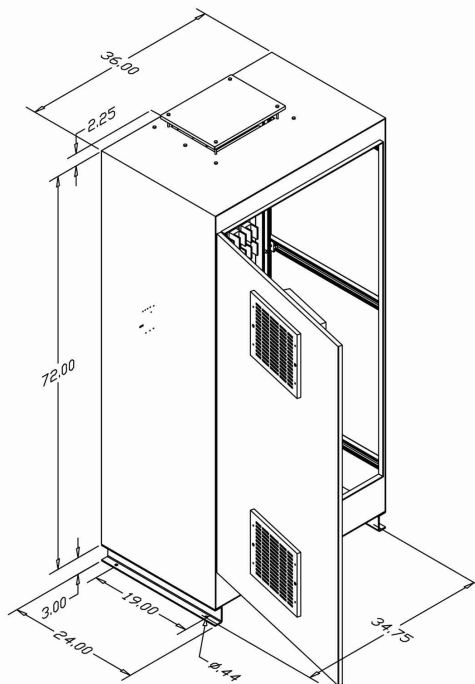
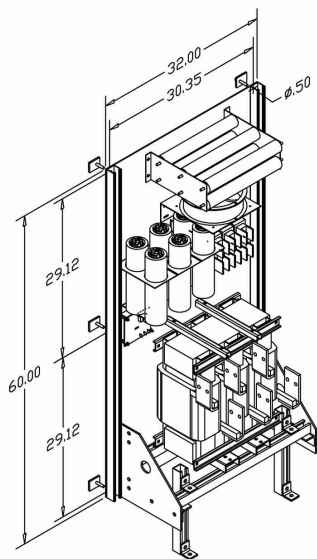
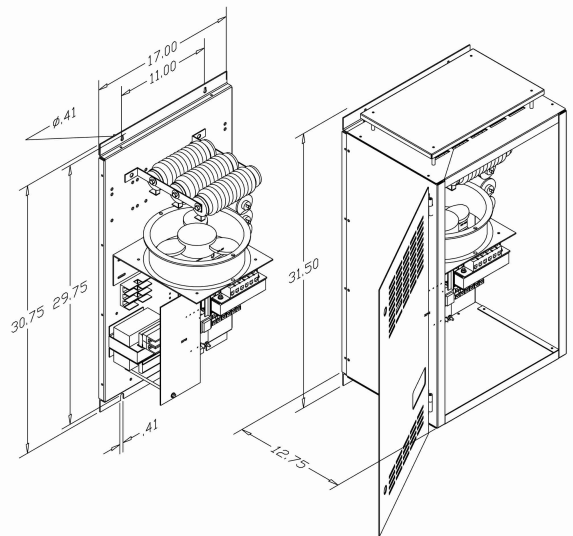
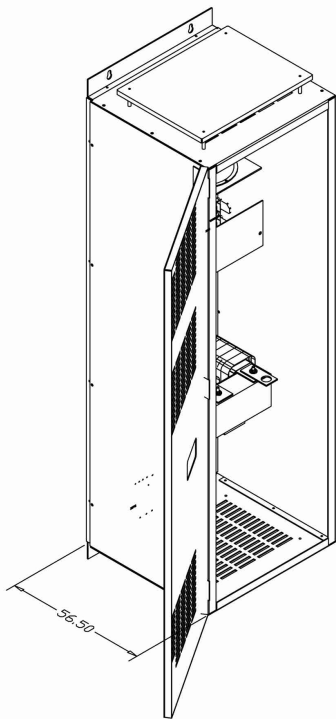
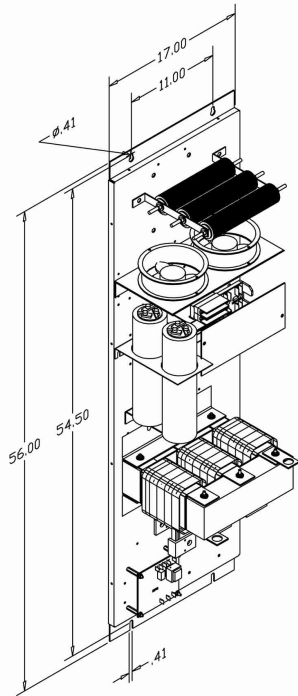

SPECS

MOTORGUARD™ Product Specifications

- Available in 480V and 600V designs
- UL-Listed (Industrial Control Panel)
- 1 Year Warranty
- Available in Standard 5 through 600 HP
- NEMA 1 enclosures available
- Protection Monitor Board
- Specific applications can reach 15,000 feet
- Voltage Distortion at 5% (Typical)
- Performance guarantee



Performance and Protection For Drives

TRANS-COIL, INC.

7878 North 86th Street, Milwaukee, WI 53224

PHONE 1-800-824-8282 **FAX** (414) 357-4484

WEB www.transcoil.com